

QUIETSCROLL TWIN FAN RANGE

MOST
COMPREHENSIVE
RANGE OF TWIN
FANS WITH INTEGRAL
ENERGY-SAVING
CONTROLS

CONTENTS

3	ABOUT QUIETSCROLL
4	QUIETSCROLL RANGE
6	ACOUSTIC DATA
10	SENSORS & ENABLERS
11	ANCILLARIES
12	DEMAND VENTILLATION
13	BENEFITS
14	CONSTANT PRESSURE
16	PERFORMANCE & TECHNICAL
17	CONSULTANT SPECIFICATION

PROUD TO BUILD BRITISH



We've been pioneers in new air technology since 1966. Our heritage is in the design and manufacturing of fans and ventilation systems. *We put our energy into efficient ventilation so you don't waste yours.*



Pioneering

We lead the way in product innovation with a stream of ground-breaking products over decades.



Trusted

We have a reputation for our build quality. We establish long term relationships and are always transparent with our test data.



Agile

We're one of the UK's leading manufacturers, covering both residential and commercial air quality. We offer innovative advice and provide flexible solutions.



Expert

Our team is made up of over 600 people, 50 of which have over 25 years' experience. We have the skills and knowledge to help find the best solution for our customers.



Attentive

We're expert listeners, rising to any challenge and going the extra mile for our customers. We add value by solving problems. We sell solutions, not fans.



Personal

We work closely with our customers and can provide bespoke solutions to meet their specific project needs. Many of our product ranges were developed this way.

“Our expertise, experience and innovation are what makes us stand out from the rest of the market.”

Nuaire.



For help with selecting a unit, speak to us on **02920 858200** or email: enquiries@nuaire.co.uk

ABOUT QUIETSCROLL TWIN FAN RANGE

Quiet, high duty with integral energy-saving and controls from the innovator of twin fans.

SUPPLY AND EXTRACT

A Nuaire supply unit can be interlinked with a twin fan to provide a cost-effective controllable solution for your system requirements – both fans responding to single or multiple sensors/controls.

IMPROVED LIFECYCLE

Auto duty share every 12 hours ensuring maximum life from fans.

WARRANTY

Ecosmart Quietscroll twin fans have a 5 year warranty.

PURE DEMAND VENTILATION

Only ventilates the room when required - maximum energy savings possible achieved.

PLUG-IN CONTROLS

All sensors and controls (a maximum of 32) are complete with 10m lengths of low voltage pre-plugged cable, (extra lengths available). You decide which conditions to monitor and the system will operate at the optimum speed for that condition.

ANCILLARIES

A wide range of ancillaries are available.

CONSTANT PRESSURE RANGE

Constant pressure range available on all models.

HEALTHY ATMOSPHERE

Ecosmart has a “trickle function” as standard which when activated enables you to set a background ventilation rate, keeping the rooms fresh whilst still saving energy.

INTEGRATED SILENCER

The unique integrated silencer (direct drive models) means that your in-duct acoustic requirements may be reduced and subsequently save you space on site. Contact Nuaire for details.

EASY MAINTENANCE

Removable top or bottom panels for easy access.

NO SYSTEM OVERLOADS

Ecosmart is pre-programmed with a soft-start function which prevents electrical overloading and minimises mechanical wear.

SIMPLE TO INSTALL AND COMMISSION

All controls pre-assembled and installed – site time kept to a minimum. Integrated simple-to-adjust speed control – no need for main balancing damper which can waste energy and generate noise.

BMS INTERFACE

Integrated BMS features enable any central system to monitor the fan/air handling unit.

Note: The control box on sizes EST 1-9 can be moved to the opposite side of the Twin Fan.



QUIETSCROLL RANGE

CODE DESCRIPTIONS

EST 19B - X

1 2 3 4

- 1 Quietscroll Twin range.
- 2 Case sizes 19 to 20.
- 3 A,B,C & D refer to motor & pulley combination (Case size 20 only).
- 4 No suffix = internal in-line unit.
 - X = external in-line unit.
 - R = black, inlet, grille outlet external roof mounted unit.
 - B = bottom inlet, grille outlet external roof mounted unit.

NOTE: EST19 units are direct drive, EST20 units are belt drive.

EST19H(-X)

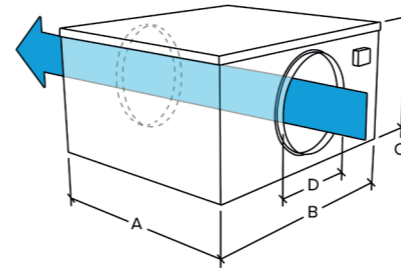

EST19H-R

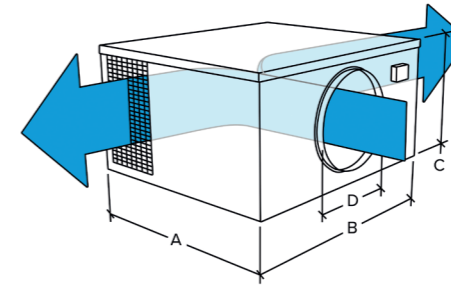

EST19H-B

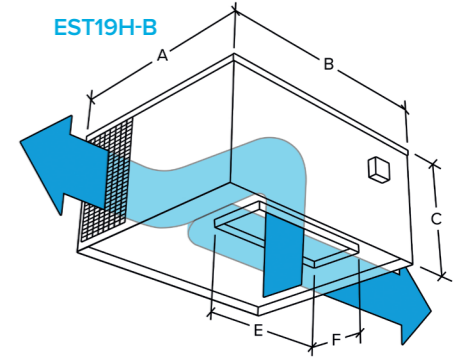

EST20H(-X)

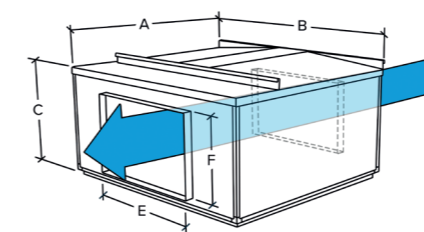

EST20H-R

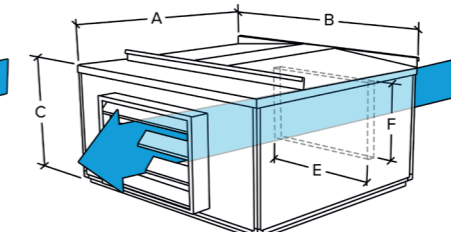

EST20H-B

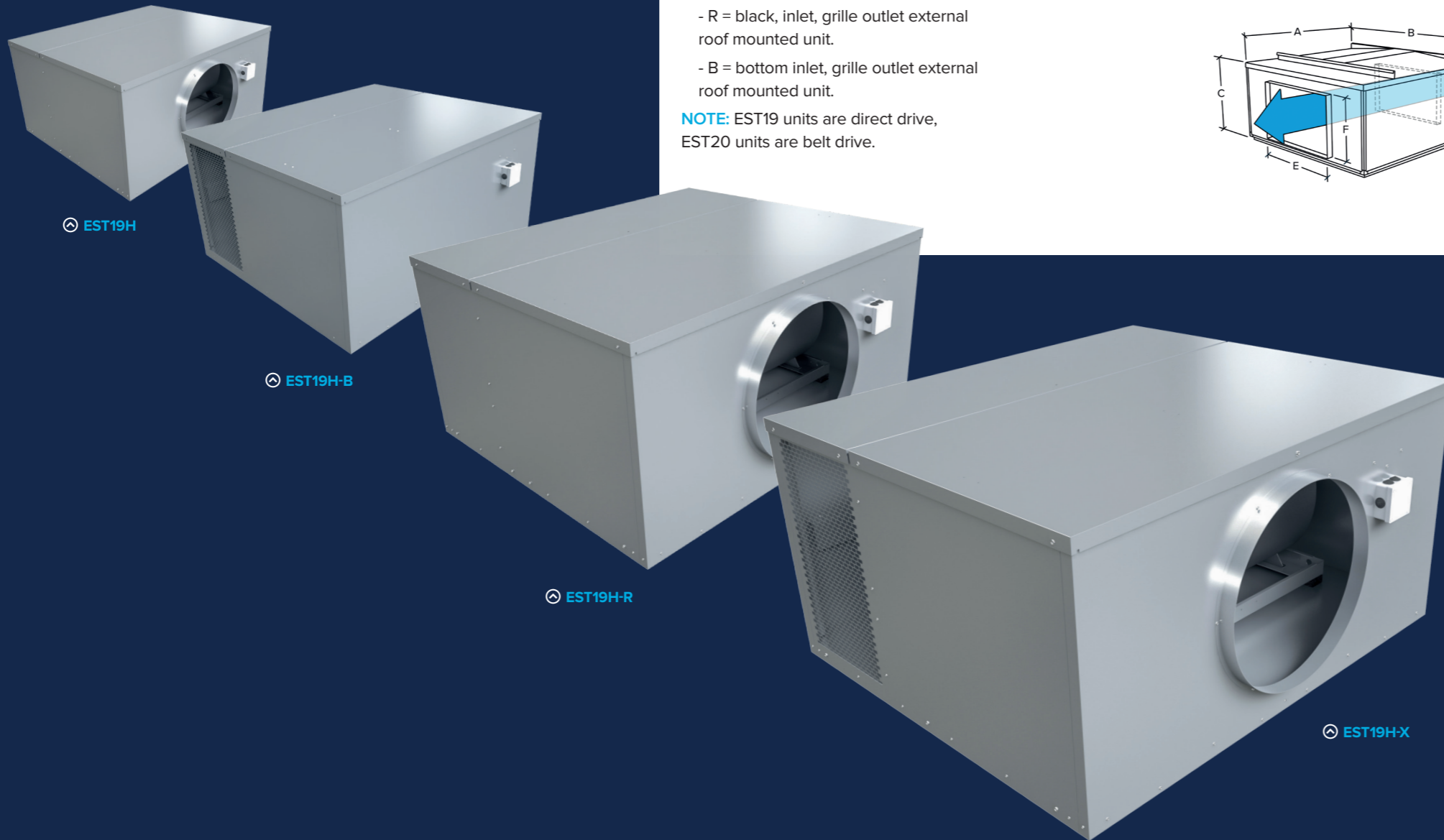
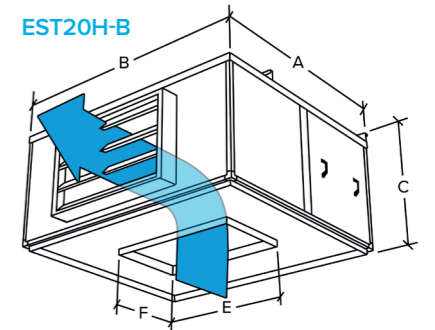

DIMENSIONS EST-19 (mm)

CODE	A	B	C	D	WEIGHT (kg)
EST	1430	1635	780	630	232

DIMENSIONS EST-20 (mm)

CODE	A	B	C	E	F	WEIGHT (kg)
EST	2030	2313	1183	1200	700	697

NOTE

All Twin Fans incorporate Ecosmart Controls as standard.

Comprising:

- Auto changeover
- Auto duty share
- Integral control BMS interfaces
- Trickle and boost facility
- Easy commissioning adjustment
- External control parts
- Run and fail volt free contacts
- Speed control



QUIETSCROLL
ACOUSTIC DATA

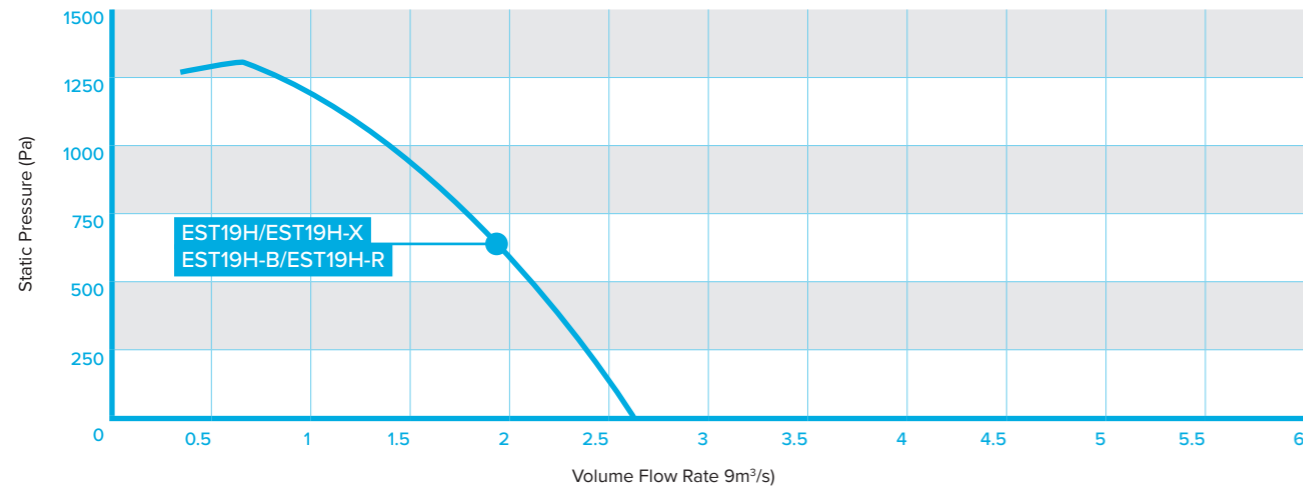

EST19H/EST19H-X

FAN SPEED	PHASE	RPM	MOTOR POWER (kW)	FLC (amps)	SC (amps)	SOUND POWER LEVELS (dB re 1pW)	SOUND POWER LEVELS RE 1 pWatts (Hz)								dBA@3m	MAX DUTY (m³/s)
							63	125	250	500	1000	2000	4000	8000		
100%	3	2600	3.2	5.2	5.2	Induct Inlet	94	89	92	88	86	85	79	75	68	2.6
						Induct Outlet	96	92	96	93	93	89	82	76		
						Breakout	83	76	89	83	83	77	68	60		

EST19H-B/EST19H-R

100%	3	2600	3.182	5.2	5.2	Induct Inlet	94	89	92	88	86	85	79	75	74	2.6
						Induct Outlet	87	88	94	92	92	89	82	76		
						Breakout	94	89	92	88	86	85	79	75		

QUIETSCROLL
ACOUSTIC DATA

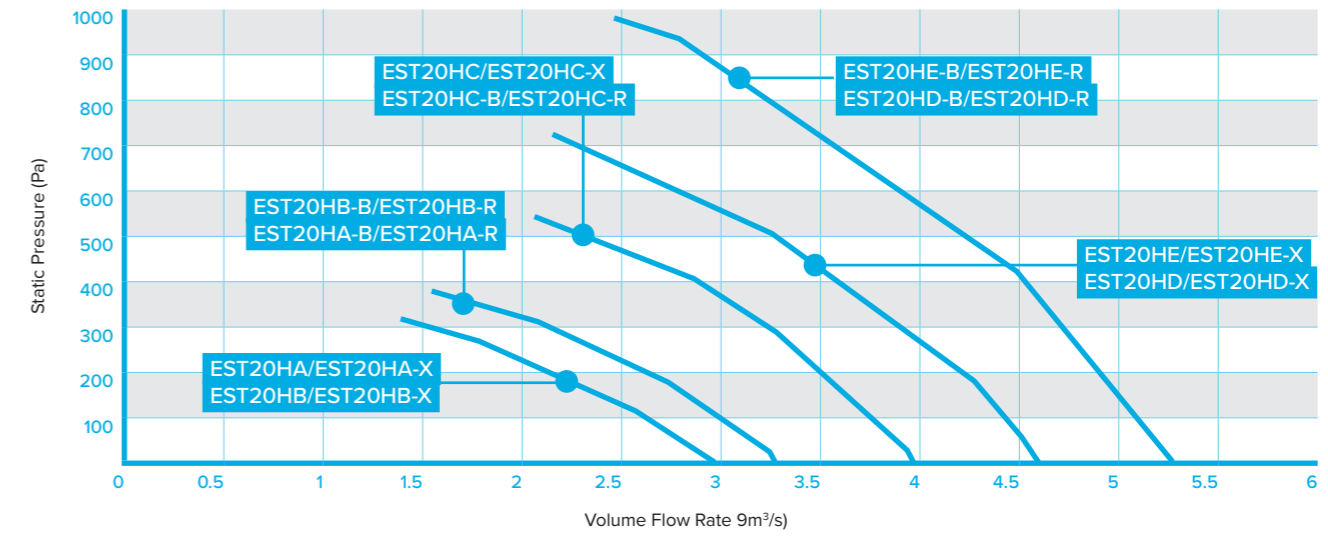

EST20HC/EST20HC-X

FAN SPEED	PHASE	RPM	MOTOR POWER (kW)	FLC (amps)	SC (amps)	SOUND POWER LEVELS (dB re 1pW)	SOUND POWER LEVELS RE 1 pWatts (Hz)								dBA@3m	MAX DUTY (m³/s)
							63	125	250	500	1000	2000	4000	8000		
100%	3	1200	2	10	10	Induct Inlet	85	83	83	84	78	76	71	66	61	4
						Induct Outlet	97	90	88	85	83	79	73	68		
						Breakout	87	74	83	77	73	67	58	52		

EST20HC-B/EST20HC-R

100%	3	1200	2	10	10	Induct Inlet	85	83	83	84	78	76	71	66	70	4
						Induct Outlet	91	86	87	85	83	79	73	68		
						Breakout	91	86	87	85	83	79	73	68		



QUIETSCROLL
ACOUSTIC DATA

QUIETSCROLL
ACOUSTIC DATA

EST20HA/EST20HA-X

FAN SPEED	PHASE	RPM	MOTOR POWER (kW)	FLC (amps)	SC (amps)	SOUND POWER LEVELS (dB re 1pW)	SOUND POWER LEVELS RE 1 pWatts (Hz)								dBA@3m	MAX DUTY (m³/s)
							63	125	250	500	1000	2000	4000	8000		
100%	3	900	0.8	6.9	6.9	Induct Inlet	77	75	75	76	70	68	63	58	53	3
						Induct Outlet	89	82	80	77	75	71	65	60		
						Breakout	79	66	75	69	65	59	50	44		

EST20HB/EST20HB-X

FAN SPEED	PHASE	RPM	MOTOR POWER (kW)	FLC (amps)	SC (amps)	SOUND POWER LEVELS (dB re 1pW)	SOUND POWER LEVELS RE 1 pWatts (Hz)								dBA@3m	MAX DUTY (m³/s)
							63	125	250	500	1000	2000	4000	8000		
100%	3	1000	1.3	10	10	Induct Inlet	80	78	78	79	73	71	66	61	56	3.3
						Induct Outlet	92	85	83	80	78	74	68	63		
						Breakout	82	69	69	72	68	62	53	47		

EST20HA-B/EST20HA-R

100%	3	900	0.8	6.9	6.9	Induct Inlet	77	75	75	76	70	68	63	58	62	3
						Induct Outlet	83	78	79	77	75	71	65	60		
						Breakout	83	78	79	77	75	71	65	60		

EST20HB-B/EST20HB-R

100%	3	1000	1.3	10	10	Induct Inlet	80	78	78	79	73	71	66	61	65	3.3
						Induct Outlet	86	81	82	80	78	74	68	63		
						Breakout	86	81	82	80	78	74	68	63		

EST20HE/EST20HE-X

FAN SPEED	PHASE	RPM	MOTOR POWER (kW)	FLC (amps)	SC (amps)	SOUND POWER LEVELS (dB re 1pW)	SOUND POWER LEVELS RE 1 pWatts (Hz)								dBA@3m	MAX DUTY (m³/s)
							63	125	250	500	1000	2000	4000	8000		
100%	3	1600	5	16	16	Induct Inlet	92	90	90	91	85	83	78	73	68	5.3
						Induct Outlet	104	97	95	92	90	86	80	75		
						Breakout	94	81	90	84	80	74	65	59		

EST20HD/EST20HD-X

FAN SPEED	PHASE	RPM	MOTOR POWER (kW)	FLC (amps)	SC (amps)	SOUND POWER LEVELS (dB re 1pW)	SOUND POWER LEVELS RE 1 pWatts (Hz)								dBA@3m	MAX DUTY (m³/s)
							63	125	250	500	1000	2000	4000	8000		
100%	3	1400	3.4	16	16	Induct Inlet	88	86	86	87	81	79	74	69	64	4.6
						Induct Outlet	100	93	91	88	86	82	76	71		
						Breakout	90	77	86	80	76	70	61	55		

EST20HE-B/EST20HE-R

100%	3	1600	5	16	16	Induct Inlet	92	90	90	91	85	83	78	73	77	5.3
						Induct Outlet	98	93	94	92	90	86	80	75		
						Breakout	98	93	94	92	90	86	80	75		











EST20HD-B/EST20HD-R

100%	3	1400	3.4	16	16	Induct Inlet	88	86	86	87	81	79	74	69	73	4.6
						Induct Outlet	94	89	90	88	86	82	76	71		
						Breakout	94	89	90	88	86	82	76	71		

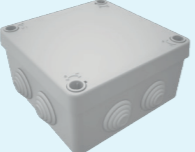
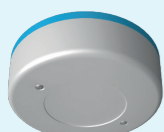
QUIETSCROLL SENSORS & ENABLERS

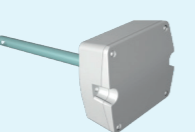
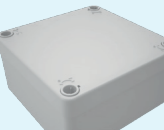

All Ecosmart Classic Systems must include at least one enabler. (N.B. when used, BMS control and time clocks take over all other enablers).

 <p>ES-PIR2 (ENABLER) Detects movement and activates system. Incorporates a system status LED, overrun timer and timer adjustment.</p>	 <p>ES-TEMP2 TEMPERATURE (SENSOR) Modulate fan speed based on room temperature. Incorporates two system status LEDs. (Green = OK, Red = Failure) and temperature set point level adjustment.</p>
 <p>ES-THERMOSTAT2 (ENABLER) Activates the system when the temperature is above set point. Incorporates two system status LEDs. (Green = OK, Red = Failure) and temperature set point level adjustment.</p>	 <p>ES-RH2 RELATIVE HUMIDITY (SENSOR) Modulate fan speed based on RH level. Incorporates two system status LEDs. (Green = OK, Red = Failure) and RH set point level adjustment.</p>
 <p>ES-AVI2 (ENABLER) When fan failure occurs the AVI will flash a warning. Supplied with pre-plugged 10m length of communication cable.</p>	 <p>ES-CI SEMI-AUTOMATIC USER CONTROL Fan, heating & cooling selected by external volt free switch, speed selected by 0-10V signal.</p>
 <p>ES-HUMIDISTAT2 (ENABLER) Activates the system when the RH level is above set point. Incorporates two system status LEDs. (Green = OK, Red = Failure) and RH set point level adjustment.</p>	 <p>ES-JB JUNCTION BOX Designed to be compatible with Ecosmart System, this unit is supplied with a preplugged 10 metre length of communications cable and has 8 further ports.</p>
 <p>ES-CO₂RM / ES-CO₂RMPP (SENSOR) Surface mounted room carbon dioxide (CO₂) sensors incorporate a temperature sensor. RM = SELV option, RMPP complete with SELV AC powers supply.</p>	 <p>ES-CO₂ (SENSOR) Duct mounted sensor to modulate fan speed based on CO₂ levels. Connect to fan directly. Pre-wired with 2m cable (not adjustable).</p>
 <p>ES-HTCSIG (ENABLER) Signal conditioning circuit for humidity, temperature and CO₂ sensors.</p>	 <p>SWITCHED LIVE (BY OTHERS) Any mains voltage signal connected to the switched live terminal (S/L) in the unit. This affects the connected fan only.</p>
<p>TOUCH SCREENS & MANUAL USER CONTROLS</p>  <p>ES-LCD/LCD2 (ENABLER) Touch screen user control in white incorporating time clock facility. This can control the function of the fan by manual setting or using a set of timed programs.</p>	 <p>ES-UCF Manual 'on' and 'off' system user/speed control. Incorporates two system status LEDs (Green = OK, Red = Failure).</p>



QUIETSCROLL ANCILLARIES

<p>MOTORISED DAMPER</p> <p>Circular Damper 630mm dia drive open/drive close 230V~50Hz with end switches.</p>	<p>MATCHED SILENCER</p> <p>Silencers have mineral wool packed to a density greater than 45kg/m³. The mineral wool is inert, non-combustible and vermin proof for long life and safety. Casing is manufactured from 'Solissime' coated galvanised steel, and designed for fixing directly to the fan outlet. Fan spigot used on open end of matched silencer.</p>	<p>CIRCULAR FLEXIBLE CONNECTOR</p> <p>Flexible material is flame resistant to BS476 part 7 with galvanised steel spigots. Heat resistant to 132°C with excellent resistance to chemicals, oil and grease. Connector is airtight and waterproof.</p>	<p>PREFABRICATED CURB</p> <p>Manufactured in aluminium alloy these curbs will reduce design work and guarantee correct unit mounting when on site. Note: Upper faces of curb are fitted with robust sealing strip.</p>
---	--	--	---

QUICK SELECTION GUIDE

EST19H		EST20H	
CA63S	Short, Circular Silencer	CA100S	Short, Circular Silencer
CA63SP	Short, Circular, Podded Silencer	CA100P	Short, Circular, Podded Silencer
CA63L	Long, Circular Silencer	CA100L	Long, Circular Silencer
CA63LP	Long, Circular, Podded Silencer	CA100LP	Long, Circular, Podded Silencer
CFC63	Circular Flexible Connector	FXRC11	Rectangular Flexible Connector
ESCD630	Circular Motorised Damper		



ON DEMAND VENTILATION WHEN YOU NEED IT MOST

Typical applications include Schools, Hotels, Apartments & Nursing Homes.

QUIETSCROLL BENEFITS

PRECISE VENTILATION

The only multi-room ventilation system to provide local 'on demand' control.

GUARANTEED VENTILATION

'Hall effect' airflow sensor provides 12 hour automatic changer in the event of fan/motor failure, guaranteeing ventilation 24/7.

QUIET OPERATION

Does not generate noise by throttling back on balancing dampers required in conventional systems.

TRUE DEMAND VENTILATION

Only the areas requiring ventilation receive ventilation.

SAVES ENERGY

Up to 70% saving over conventionally controlled central systems.

- Not needlessly extracting conditioned air
- Fan speed/motor power dictated by demand requirement.

UNIQUE DIRECT ACTING MULTI-POSITION DAMPER NRG GRILLE

Ensures operation only when room occupied with integrated PIR.

PRE-WIRED

All components assembled, wired and tested at the Nuair manufacturing facility.

- Simply plug and go. No wiring required between fan and dampers.

MATCHED SILENCER OPTIONS

Double walled Magnelis® construction and 35mm infill acoustic lining providing the best acoustic solution.

Note: External units are not fully acoustic lined as standard.

DUCT MOUNTED CVD DAMPER

For unobtrusive flexibility.

INTERNAL OR EXTERNAL

Twin fan options are available in internal or external up to 5.9m³/s. For larger duties contact Nuair.

LESS POWER CONSUMPTION

System works at reduced duty therefore consumes less power and is very quiet.

WARRANTY

Ecosmart Constant Pressure has a 5 year warranty.

Note: These units have the pressure sensor configured for extract application. For supply applications please contact Nuair.

Note: External fans and silencers have pitched roofs.

Note: For further details on Constant Pressure single fan options, please contact Nuair.

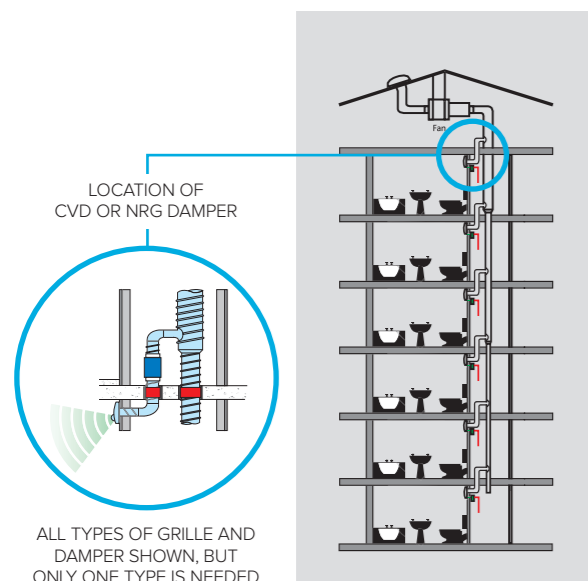

Nuair Ecosmart Constant Pressure systems are designed for continuous ventilation and because they feature Ecosmart on demand control, costs are kept low.

When a room is occupied, a PIR or switch triggers the damper, which immediately operates as required, returning to background ventilation when the room is vacated. The Constant Pressure Twin Fan offers up to 70% savings over conventionally controlled central systems and should the primary fan or motor fail, the automatic change over guarantees uninterrupted ventilation because it works at reduced duty the unit consumes less power and is very quiet. This energy efficient ventilation solution is extremely cost effective to run and simple to install as all components are delivered assembled, wired and tested. Specify Nuair Ecosmart Constant Pressure and blow away your client's energy bills.

WHAT IS CONSTANT PRESSURE?

Constant Pressure Variable Volume systems (CPVV) are systems of fans, controls & sensors installed in a multi-room ducted system. The system is intended to provide continuous background ventilation when the served spaces are unoccupied and will automatically increase the ventilation rate when any room is occupied to the design requirements. Only the room requiring the increased ventilation will receive the ventilation.

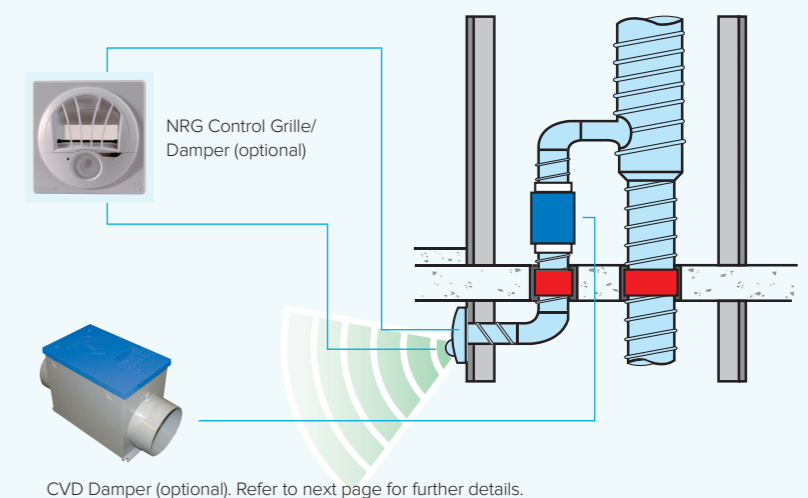

QUIETSCROLL CONSTANT PRESSURE

HOW DOES CONSTANT PRESSURE WORK?

Independent extract grilles are installed at duct termination points in each of the spaces served, the grilles (for the benefit of this exercise we will consider our NRG grilles) are set to provide one of four boost ventilation rates. They are connected independently to a 230V AC supply via 230/12V transformers.

The grilles have in built occupancy sensors (PIR) and when the PIR detects movement the grille is driven open, when a grille opens the system pressure falls, the fan control detects the change and adjusts the motor speed to maintain the target pressure.

Grilles will stay open for approximately twenty minutes after the last movement has been seen and when it closes the control again compensates for the change in system pressure by adjusting fan speed.

By opening the grilles the pressure in the system will fall. The control system in the fan senses this and automatically speeds up to provide the higher volume and equalise the system pressure. This works in reverse with the grille closing, increasing the system pressure, automatically reducing the fan speed and again equalising the system pressure. Hence a constant pressure variable volume system. There is no inter-connection between grille/damper and fan.

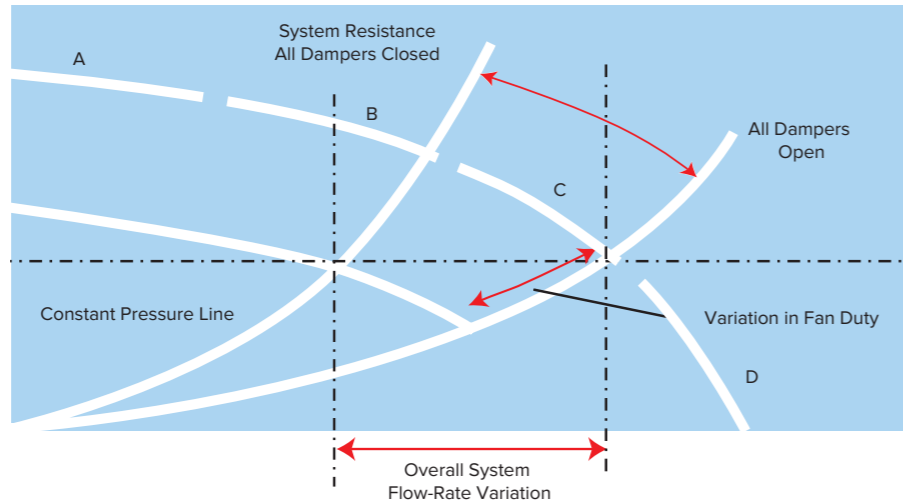

- An integral occupancy sensor (PIR) which is not adjustable.
- They are 12V-AC operating and are supplied with 230/12V-AC transformers for installation local to the grille. For ease of installation the transformer can be connected to an independent spur or ring main.
- Integrated run on timer providing approx. twenty minutes overrun, which is non-adjustable.
- Grille resistance is dependent upon the air volume passing through it, see the resistance charts.
- There is no interconnecting wiring between damper/grille & fan.

THE INTEGRATED CONTROL PACKAGE

Is mounted in the fan chamber and consists of the EST package including:

- The inverter, which is the mechanism that varies the speed of the motors.
- A Ecosmart control printed circuit board which converts the data from the pressure transducer to an input signal to the inverter.
- Terminals to connect the incoming mains supply and remote status indicators.

THE PRESSURE TRANSDUCER

Is precisely calibrated and mounted in the fan chamber and is connected to the Ecosmart control board. It continually monitors system pressure, compares the actual to the target allowing the control board to convert the data to an input signal to the inverter, thereby adjusting the motor speed to compensate for the system change.

THE SET-UP BOX

Is mounted on the external face of the unit case, it is connected to the control pack by a low voltage lead and includes:

- A potentiometer to set the target pressure.

All achieved whilst fan is running without re accessing the fan chamber.



WHAT ARE NRG GRILLES?

A motorised two-position grille offered by Nuair to compliment the range of constant pressure fans. They have:

- A connecting spigot to suit 125mm duct opening.
- Four settable positions for boost vent rate, Positions 1, 2, 3 & 4 are indicated on the grille by the appropriate number of dots. The grille is pre-set at 5mm open to guarantee the trickle ventilation rate and the other positions are set via a trigger on the front of the grille.



CVD DAMPER

The CVD damper will work in the same way as the NRG but is mounted in-line and will be 230v operated responding to external switching devices such as humidistat, remote PIR, light switch, door switch etc. The in-line version has an in built motorised volume control damper to regulate the maximum flow through the branch connection. It has an airflow sensor that continuously monitors the airflow and adjusts the damper position accordingly.

QUIETSCROLL CONSTANT PRESSURE

PERFORMANCE - CVD DAMPER

A nominal pressure drop must be allowed in order to ensure adequate airflow through the damper. To ensure the airflow pattern through the damper produces consistent readings; the pressure drop across the damper should not exceed the recommended value. Recommended values are listed in the table below and shown in the performance envelope of each damper.

*Recommended maximum operating pressure to ensure the damper would work within calibration limits. Keep the duct velocity as low as possible to ensure the system produces the lowest energy usage, preferably below 5m/s.

**Allow 90Pa for duties below 100l/s and 150Pa for duties between 100l/s and 125l/s.

CODE	NOMINAL DESIGN PRESSURE DROP	MAXIMUM PRESSURE ACROSS DAMPER*
CVD100	60Pa	120Pa
CVD125	70Pa	140Pa
CVD150	80Pa	160Pa
CVD200	90Pa**	200Pa

Performance envelope for CVD100

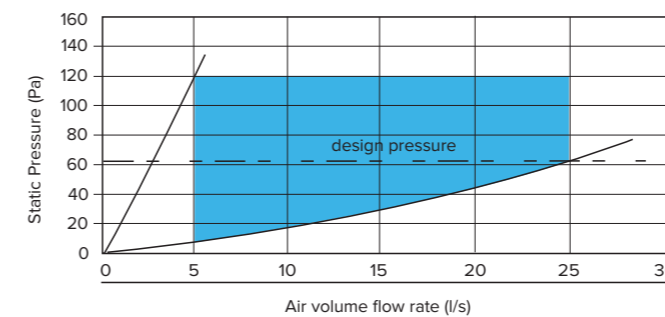

CVD100 Settings

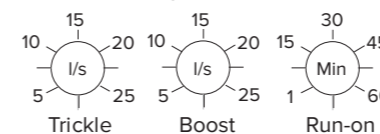

Performance envelope for CVD125

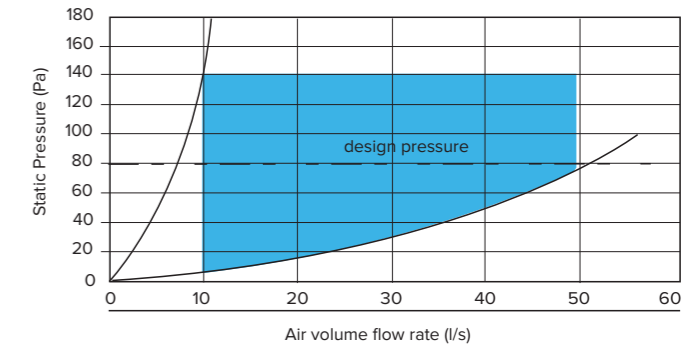

Dial calibration for CVD125

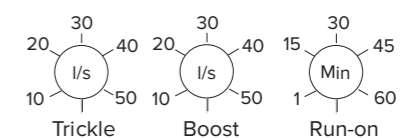

Performance envelope for CVD150

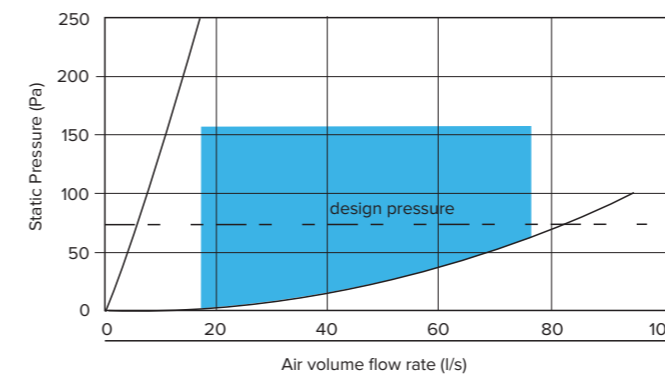

Dial calibration for CVD150

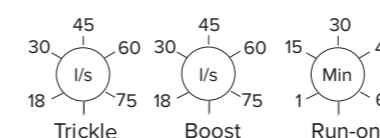

Performance envelope for CVD200

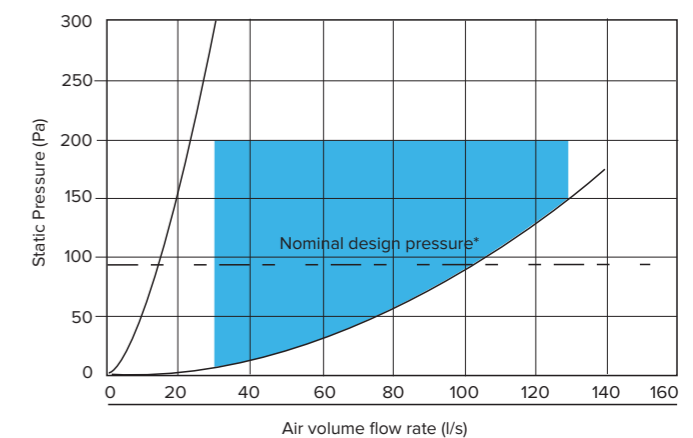

Dial calibration for CVD200

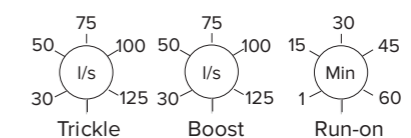

QUIETSCROLL PERFORMANCE AND TECHNICAL INFORMATION

QUIETSCROLL CONSULTANT SPECIFICATION

DIMENSIONS (mm) CVD DAMPERS

CODE	A	B	C	D	E	F	WEIGHT (kg)
CVD100	221	128	165	100	69	295	2
CVD125	300	180	195	125	75	400	3.5
CVD150	300	200	220	150	90	400	3.7
CVD200	300	230	275	200	115	400	4

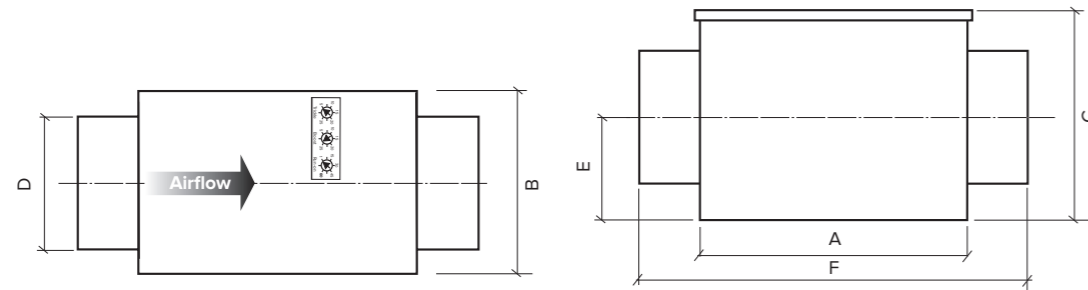

PERFORMANCE - NRG MOTORISED GRILLE/DAMPER

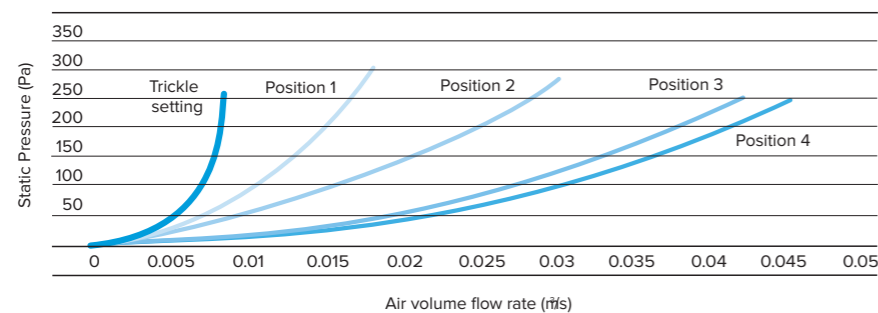

WHAT ARE NRG GRILLES?

A motorised two-position grille offered by Nuair to compliment the range of constant pressure fans. They have:

- A connecting spigot to suit 125mm duct opening.
- Four settable positions for boost vent rate, Positions 1, 2, 3 & 4 are indicated on the grille by the appropriate number of dots. The grille is preset at 5mm open to guarantee the trickle ventilation rate and the other positions are set via a trigger on the front of the grille.

DIMENSIONS NRG GRILLE DAMPER

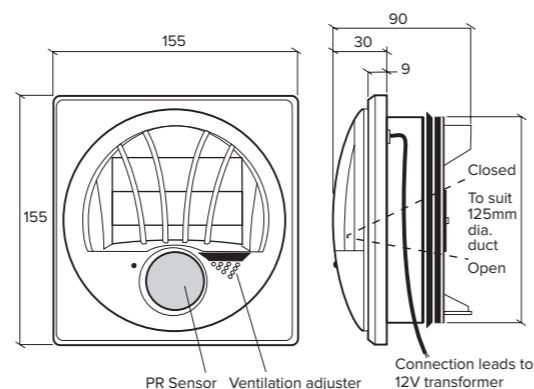

VENTILATION SYSTEM DESCRIPTION

The main extract twin fan shall be as indicated on the drawings and in accordance with the relevant fan schedule. The ventilated air shall be extracted from the space using an energy-efficient demand ventilation principle; the system shall have its volume flow rate of air varied by a range of low voltage sensors and enablers.

INSTALLATION REQUIREMENTS

The mechanical contractor shall ensure that all necessary ancillaries are included e.g. AV mounts, flexible connections, attenuators, etc. The contractor shall allow for all necessary ductwork transformations to and from the fan unit and any associated components in accordance with the manufacturers recommendations, DW 144 and general good practice.

FAN AND CONTROL DESCRIPTION

The unit shall be manufactured from heavy gauge, corrosion resistant Magnelis® steel, internally coated with fire retardant acoustic material. Fully detachable panels for maintenance/ service and manometer test points.

Fan assemblies incorporate backward curved centrifugal impellers belt driven (EST20H*) by BS5000 motors and fitted with air flow fail monitors. EST19H* impellers are directly driven by EC motors and fitted with air flow fail monitors.

The fan should be fitted with an Ecosmart Classic control together with an inverter speed controller. The fan shall have the following energy saving functions integrally mounted within the fan unit on a purpose made PCB, all components pre-wired by the manufacturer: integral maximum and minimum speed adjustment/setting; integral auto changeover/duty share, fans changeover every 12 hours of run time; integral adjustable run-on timer; integral BMS interfaces, 0-10v and volt free failure indication.

SYSTEM OPERATION

The extract fan shall automatically vary its speed as it receives signals from one of the interconnected sensors. When the signal is received the fan shall either increase speed gradually until the required level is achieved or it will work on a trickle and boost principle.

This will then move the fan duty point from trickle/background ventilation rate to the required boost ventilation rate. Both the trickle and boost rates are infinitely variable, easy to adjust and remove the need of a main balancing damper in accordance with Part L.

WARRANTY

Quietscroll twin fan range with Ecosmart Classic control has a 5 year manufacturers warranty.

*All derivatives i.e -B, -R, -X and inline.



COMMERCIAL

WWW.NUAIRE.CO.UK/COMMERCIAL



RESIDENTIAL

WWW.NUAIRE.CO.UK/RESIDENTIAL



INTERNATIONAL

WWW.NUAIRE.CO.UK/INTERNATIONAL



WESTERN INDUSTRIAL ESTATE | CAERPHILLY | CF83 1NA
T 029 2085 8200 **F** 029 2085 8300 **E** INFO@NUAIRE.CO.UK
WWW.NUAIRE.CO.UK

Part no. 672101
v1 July 2023